



# TR81

## MAIN FEATURES

- Subminiature, Light Weight
- Big Gap Type Available for Heavy Motor Load Switching
- Improved Resistance to Shock and Vibration
- High Contact Current Capacity
- Automotive-Oriented design

## APPLICATIONS IN

- Interval Wipers
- Door Lock
- Window Lifter
- Alarm System
- Wiper Motor Reverse
- Automatic Mirror Adjustment
- Fuel Pump Control
- Belt Tension Adjustment



勝特力材料 886-3-5753170  
 勝特力电子(上海) 86-21-54151736  
 勝特力电子(深圳) 86-755-83298787  
[Http://www.100y.com.tw](http://www.100y.com.tw)

## ORDERING INFORMATION

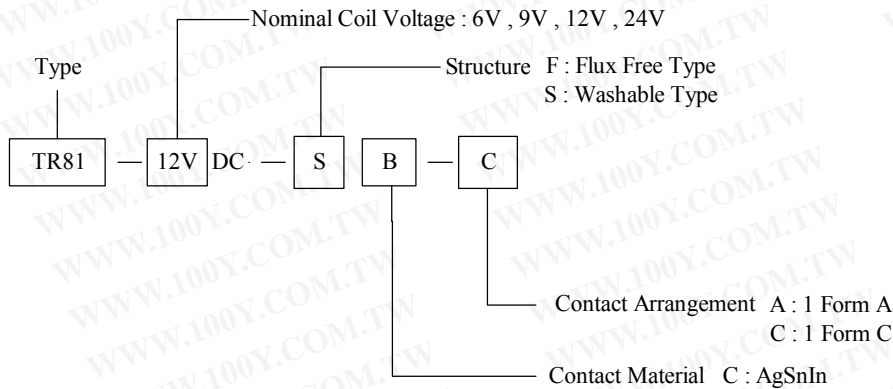

## DIMENSION (unit:mm)

## DRILLING (unit:mm)

## WIRING DIAGRAM

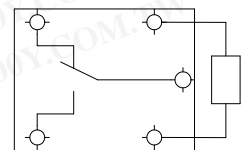
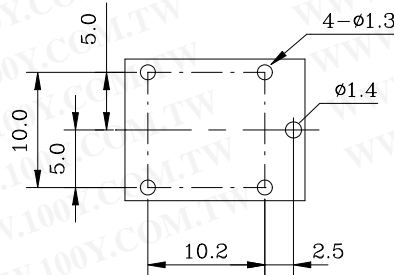
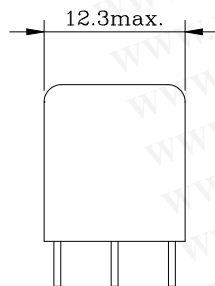
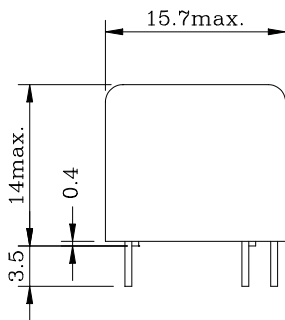

### COIL DATA CHART (AT20°C)

Coil Sensitivity	Coil Voltage Code	Nominal Voltage (VDC)	Nominal Current (mA)	Coil Resistance (Ω) ±10%	Power Consumption (W)	Pull-In Voltage (VDC)	Drop-Out Voltage (VDC)	Max-Allowable Voltage (VDC)
TR81-D	06	6	100	60	abt. 0.6	80% Max.	5% Min.	150%
	09	9	66.7	135				
	12	12	50	240				
	24	24	25	960				

### CONTACT RATING

Item	Type	TR81
Contact Capacity		
Resistive Load (cosΦ=1)		N/C : 15A 14VDC , 10A 120VAC N/O : 20A 14VDC , 10A 120VAC
Inductive Load (cosΦ=0.4 L/R=7msec)		6A, 14VDC
Rated Carrying Current		25A/hr
Max. Allowable Voltage		250VAC 30VDC
Max. Allowable Current		20A
Max. Allowable Power Force		1200VA 280W
Referenced Min. Applicable Load		10mA, 5VDC
Contact Material		Ag Alloy

### REFERENCE DATA

#### 1. Coil Temperature Rise

Point Measured : Inside The Coil  
Contact Current : Now Current Through Contact. 5A, 10A, 15A, 20A  
Resistance Method, Ambient Temperature 85°C 185°C

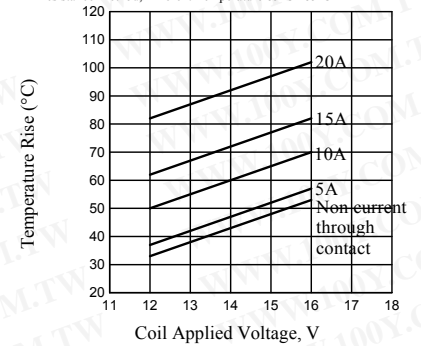

#### 2. Ambient Temperature Characteristics

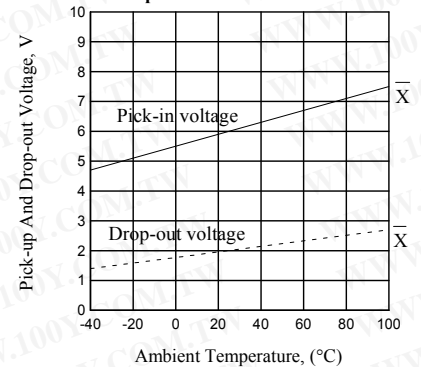

#### 3. Electrical Life Test (at rated load)

Quantity : n=6(NC=3, NO=3)  
Load : Resistive Load (NC side 2A 14VDC  
NO side 5A 14VDC)  
Operating Frequency : ON 1.5sec. OFF 1sec.  
Contact Welding : 0 time  
Misconduct : 0 time

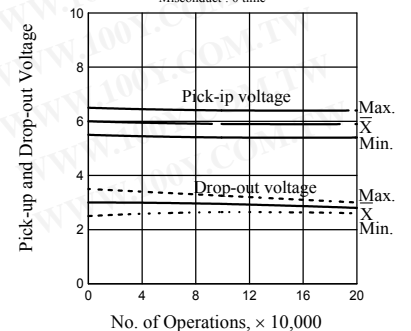

### PERFORMANCE (at initial value)

Item	Type	TR81
Contact Resistance		100mΩ Max.
Operation Time		10msec
Release Time		5msec
Dielectric Strength		
Between coil & contact		500VAC 50/60Hz (1 minute)
Between contacts		500VAC 50/60Hz (1 minute)
Surge Resistance		1500V
Insulation Resistance		100 MΩ Min. (at 500VDC)
Max. ON/OFF Switching		
Mechanically		300 operation/min
Electrically		30 operation/min
Operating Ambient Temperature		-30°C to +80°C (No water condensation and no water drop)
Operating Humidity		45 to 85% RH
Coil Temperature Rise		40 deg. Max. (at rated coil voltage)
Vibration		
Endurance		10 to 55HZ Double Amplitude 1.5mm
Error Operation		10 to 55HZ Double Amplitude 1.5mm
Shock		
Endurance		100G Min.
Error Operation		10G Min.
Life Expectancy		
Mechanically		1 × 10 <sup>6</sup> ops. Min. (no load)
Electrically		1 × 10 <sup>5</sup> ops. Min.
Weight		abt. 6grs.

勝特力材料 886-3-5753170  
 勝特力电子(上海) 86-21-54151736  
 勝特力电子(深圳) 86-755-83298787  
[Http://www.100y.com.tw](http://www.100y.com.tw)