



FEATURES

- RoHS compliant
- Single isolated output
- 1kVDC isolation
- Efficiency up to 80%
- Wide temperature performance at full 1 watt load, -40°C to 85°C
- Power density 1.53W/cm³
- UL 94V-0 package material
- Footprint from 0.69cm²
- Industry standard pinout
- 5V & 12V input
- 5V, 9V, 12V and 15V output
- No heatsink required
- Internal SMD construction
- Fully encapsulated with toroidal magnetics
- No external components required
- MTTF up to 3.4 million hours
- Custom solutions available
- Pin compatible with LME & NML series
- PCB mounting

DESCRIPTION

The NME series of DC/DC Converters is particularly suited to isolating and/or converting DC power rails. The galvanic isolation allows the device to be configured to provide an isolated negative rail in systems where only positive rails exist. The wide temperature range guarantees startup from -40°C and full 1 watt output at 85°C. For lower ripple, refer to output ripple reduction section.

SELECTION GUIDE

| Order Code | Nominal Input Voltage | Output Voltage | Output Current | Input Current at Rated Load | Efficiency | Isolation Capacitance | MTTF ¹ | Package Style |
|------------|-----------------------|----------------|----------------|-----------------------------|------------|-----------------------|-------------------|---------------|
| | V | V | mA | mA | % | pF | kHrs | |
| NME0505DC | 5 | 5 | 200 | 289 | 69 | 30 | 3415 | DIP |
| NME0509DC | 5 | 9 | 111 | 260 | 77 | 37 | 3078 | |
| NME0512DC | 5 | 12 | 83 | 256 | 78 | 33 | 2205 | |
| NME0515DC | 5 | 15 | 66 | 250 | 80 | 40 | 1532 | |
| NME0524DC | 5 | 24 | 42 | 248 | 80 | 48 | | |
| NME0505SC | 5 | 5 | 200 | 289 | 69 | 30 | 3415 | SIP |
| NME0509SC | 5 | 9 | 111 | 260 | 77 | 37 | 3078 | |
| NME0512SC | 5 | 12 | 83 | 256 | 78 | 33 | 2205 | |
| NME0515SC | 5 | 15 | 66 | 250 | 80 | 40 | 1532 | |
| NME0524SC | 5 | 24 | 42 | 248 | 80 | 48 | | |
| NME1205DC | 12 | 5 | 200 | 120 | 69 | 33 | 2493 | DIP |
| NME1209DC | 12 | 9 | 111 | 115 | 74 | 48 | 2311 | |
| NME1212DC | 12 | 12 | 83 | 105 | 76 | 55 | 1780 | |
| NME1215DC | 12 | 15 | 66 | 110 | 75 | 52 | 1313 | SIP |
| NME1205SC | 12 | 5 | 200 | 120 | 69 | 33 | 2493 | |
| NME1209SC | 12 | 9 | 111 | 115 | 74 | 48 | 2311 | |
| NME1212SC | 12 | 12 | 83 | 110 | 76 | 55 | 1780 | |
| NME1215SC | 12 | 15 | 66 | 111 | 75 | 52 | 1313 | |

INPUT CHARACTERISTICS

| Parameter | Conditions | Min. | Typ. | Max. | Units |
|--------------------------|---------------------------------------|------|------|------|--------|
| Voltage range | Continuous operation, 5V input types | 4.5 | 5.0 | 5.5 | V |
| | Continuous operation, 12V input types | 10.8 | 12.0 | 13.2 | |
| Reflected ripple current | | | 26 | 48 | mA p-p |

OUTPUT CHARACTERISTICS

| Parameter | Conditions | Min. | Typ. | Max. | Units |
|----------------------------|---|------|------|------|--------|
| Rated Power ² | T _A = -40°C to 120°C | | | 1.0 | W |
| Voltage Set Point Accuracy | See tolerance envelope | | | | |
| Line regulation | High V _{IN} to low V _{IN} | | 1.0 | 1.2 | %/% |
| | 10% load to rated load, 5V output types | | 14 | 15 | |
| | 10% load to rated load, 9V output types | | 9 | 10 | |
| | 10% load to rated load, 12V output types | | 7.5 | 9.5 | |
| | 10% load to rated load, 15V output types | | 7.0 | 8.5 | |
| | 10% load to rated load, 24V output types | | 5.5 | 7.5 | |
| Ripple and Noise | BW=DC to 20MHz, 5V output types | | 85 | 110 | mV p-p |
| | BW=DC to 20MHz, 9V output types | | 60 | 75 | |
| | BW=DC to 20MHz, 12V output types | | 50 | 65 | |
| | BW=DC to 20MHz, 15V output types | | 40 | 55 | |
| | BW=DC to 20MHz, 24V output types | | 140 | 180 | |

ABSOLUTE MAXIMUM RATINGS

| | |
|---|-------|
| Lead temperature 1.5mm from case for 10 seconds | 300°C |
| Internal power dissipation | 450mW |
| Input voltage V _{IN} , NME05 types | 7V |
| Input voltage V _{IN} , NME12 types | 15V |

1. Calculated using MIL-HDBK-217F FN2 with nominal input voltage at full load.

2. See derating curve.

All specifications typical at T_A = 25°C, nominal input voltage and rated output current unless otherwise specified.



| ISOLATION CHARACTERISTICS | | | | | |
|---------------------------|---------------------------|------|------|------|-------|
| Parameter | Conditions | Min. | Typ. | Max. | Units |
| Isolation test voltage | Flash tested for 1 second | 1000 | | | VDC |
| Resistance | Viso= 1000VDC | | 10 | | GΩ |

| GENERAL CHARACTERISTICS | | | | | |
|-------------------------|-----------------|------|------|------|-------|
| Parameter | Conditions | Min. | Typ. | Max. | Units |
| Switching frequency | 5V input types | | 110 | | kHz |
| | 12V input types | | 145 | | |

| TEMPERATURE CHARACTERISTICS | | | | | |
|--------------------------------|------------------------|------|------|------|-------|
| Parameter | Conditions | Min. | Typ. | Max. | Units |
| Specification | All output types | -40 | | 85 | °C |
| Storage | | -50 | | 130 | |
| Case Temperature above ambient | 5V output types | | | 41 | |
| | All other output types | | | 32 | |
| Cooling | Free air convection | | | | |

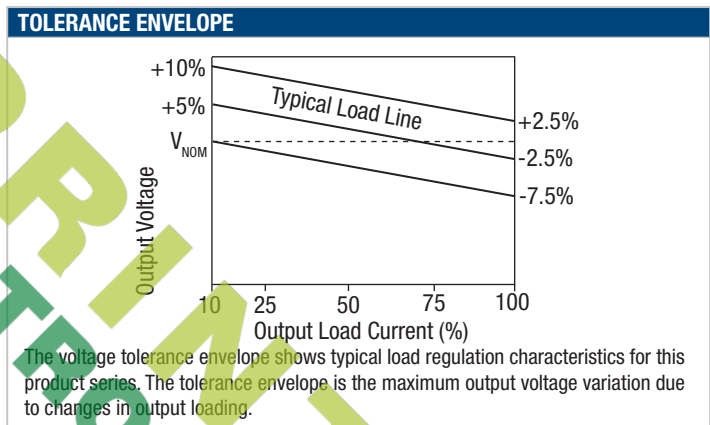
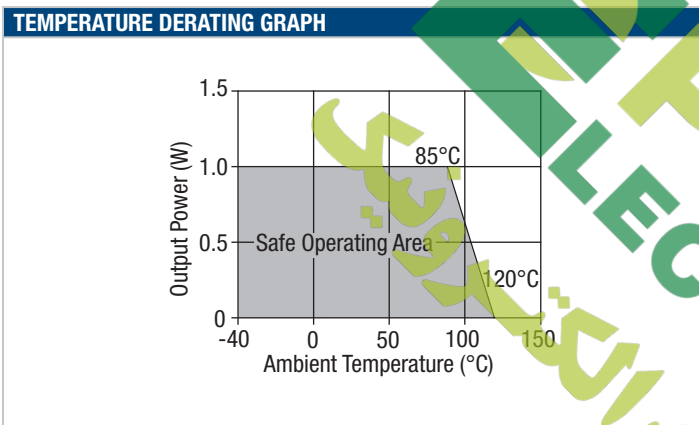

TECHNICAL NOTES

ISOLATION VOLTAGE

'Hi Pot Test', 'Flash Tested', 'Withstand Voltage', 'Proof Voltage', 'Dielectric Withstand Voltage' & 'Isolation Test Voltage' are all terms that relate to the same thing, a test voltage, applied for a specified time, across a component designed to provide electrical isolation, to verify the integrity of that isolation.

Murata Power Solutions NME series of DC/DC converters are all 100% production tested at their stated isolation voltage. This is 1kVDC for 1 second.

A question commonly asked is, "What is the continuous voltage that can be applied across the part in normal operation?"

For a part holding no specific agency approvals, such as the NME series, both input and output should normally be maintained within SELV limits i.e. less than 42.4V peak, or 60VDC. The isolation test voltage represents a measure of immunity to transient voltages and the part should never be used as an element of a safety isolation system. The part could be expected to function correctly with several hundred volts offset applied continuously across the isolation barrier; but then the circuitry on both sides of the barrier must be regarded as operating at an unsafe voltage and further isolation/insulation systems must form a barrier between these circuits and any user-accessible circuitry according to safety standard requirements.

REPEATED HIGH-VOLTAGE ISOLATION TESTING

It is well known that repeated high-voltage isolation testing of a barrier component can actually degrade isolation capability, to a lesser or greater degree depending on materials, construction and environment. The NME series has toroidal isolation transformers, with no additional insulation between primary and secondary windings of enameled wire. While parts can be expected to withstand several times the stated test voltage, the isolation capability does depend on the wire insulation. Any material, including this enamel (typically polyurethane) is susceptible to eventual chemical degradation when subject to very high applied voltages thus implying that the number of tests should be strictly limited. We therefore strongly advise against repeated high voltage isolation testing, but if it is absolutely required, that the voltage be reduced by 20% from specified test voltage.

This consideration equally applies to agency recognized parts rated for better than functional isolation where the wire enamel insulation is always supplemented by a further insulation system of physical spacing or barriers.

APPLICATION NOTES

Minimum load

The minimum load to meet datasheet specification is 10% of the full rated load across the specified input voltage range. Lower than 10% minimum loading will result in an increase in output voltage, which may rise to typically double the specified output voltage if the output load falls to less than 5%.

Capacitive loading and start up

Typical start up times for this series, with a typical input voltage rise time of 2.2 μ s and output capacitance of 10 μ F, are shown in the table below. The product series will start into a capacitance of 47 μ F with an increased start time, however, the maximum recommended output capacitance is 10 μ F.

| | Start-up time | |
|-----------|---------------|--|
| | μ s | |
| NME0505SC | 991 | |
| NME0509SC | 3524 | |
| NME0512SC | 5630 | |
| NME0515SC | 7750 | |
| NME0524SC | 19850 | |
| NME1205SC | 682 | |
| NME1209SC | 2102 | |
| NME1212SC | 4030 | |
| NME1215SC | 6193 | |

Typical Start-Up Wave Form

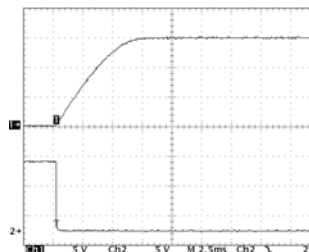

Ripple & Noise Characterisation Method

Ripple and noise measurements are performed with the following test configuration.

| | |
|-------|--|
| C1 | 1 μ F X7R multilayer ceramic capacitor, voltage rating to be a minimum of 3 times the output voltage of the DC/DC converter |
| C2 | 10 μ F tantalum capacitor, voltage rating to be a minimum of 1.5 times the output voltage of the DC/DC converter with an ESR of less than 100m Ω at 100 kHz |
| C3 | 100nF multilayer ceramic capacitor, general purpose |
| R1 | 450 Ω resistor, carbon film, \pm 1% tolerance |
| R2 | 50 Ω BNC termination |
| T1 | 3T of the coax cable through a ferrite toroid |
| RLOAD | Resistive load to the maximum power rating of the DC/DC converter. Connections should be made via twisted wires |

Measured values are multiplied by 10 to obtain the specified values.

Differential Mode Noise Test Schematic

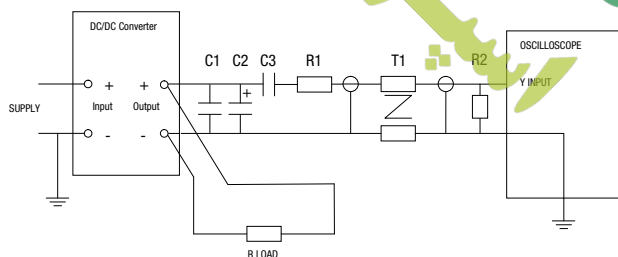

APPLICATION NOTES (continued)

Output Ripple Reduction

By using the values of inductance and capacitance stated, the output ripple at the rated load is lowered to 5mV p-p max.

Component selection

Capacitor: It is required that the ESR (Equivalent Series Resistance) should be as low as possible, ceramic types are recommended. The voltage rating should be at least twice (except for 15V output), the rated output voltage of the DC/DC converter.

Inductor: The rated current of the inductor should not be less than that of the output of the DC/DC converter. At the rated current, the DC resistance of the inductor should be such that the voltage drop across the inductor is <2% of the rated voltage of the DC/DC converter. The SRF (Self Resonant Frequency) should be >20MHz.

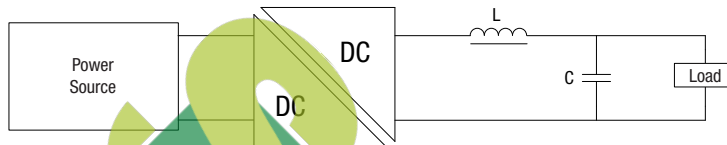

| | L, μ H | Inductor | | Capacitor |
|-----------|------------|----------|--------------|--------------|
| | | SMD | Through Hole | C, μ F |
| NME0505SC | 47 | 82473C | 11R473C | 4.7 μ F |
| NME0509SC | 47 | 82473C | 11R473C | 1 μ F |
| NME0512SC | 68 | 82683C | 11R683C | 1 μ F |
| NME0515SC | 100 | 82104C | 11R104C | 0.47 μ F |
| NME0524xC | 100 | 82104C | 11R104C | 0.47 |
| NME1205SC | 100 | 82104C | 11R104C | 4.7 μ F |
| NME1209SC | 47 | 82473C | 11R473C | 1 μ F |
| NME1212SC | 68 | 82683C | 11R683C | 0.47 μ F |
| NME1215SC | 100 | 82104C | 11R104C | 0.47 μ F |

PACKAGE SPECIFICATIONS

MECHANICAL DIMENSIONS

DIP Package

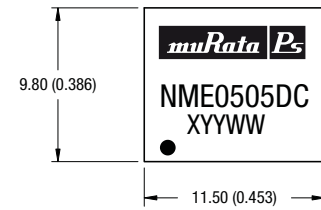

SIP Package

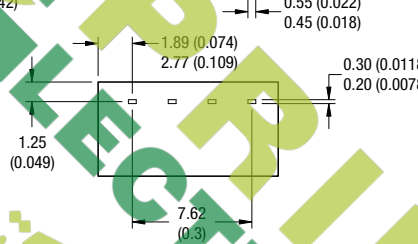
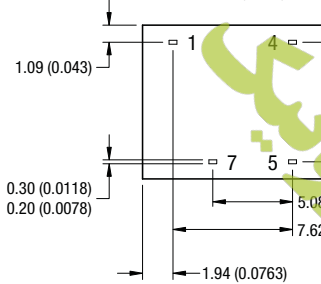
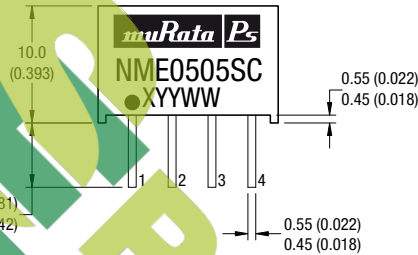
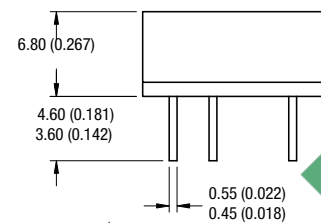
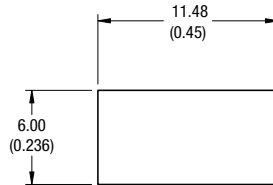

All dimensions in mm ± 0.25 mm (inches ± 0.01). All pins on a 2.54 (0.1) pitch and within ± 0.25 (0.01) of true position.

Weight: 1.30g (SIP) 1.48g (DIP)

PIN CONNECTIONS - 8 PIN DIP

| Pin | Function |
|-----|----------|
| 1 | -VIN |
| 4 | +VIN |
| 5 | +VOUT |
| 7 | -VOUT |

PIN CONNECTIONS - 4 PIN SIP

| Pin | Function |
|-----|----------|
| 1 | -VIN |
| 2 | +VIN |
| 3 | -VOUT |
| 4 | +VOUT |

PACKAGE SPECIFICATIONS (continued)

RECOMMENDED FOOTPRINT DETAILS

8 Pin DIP Package

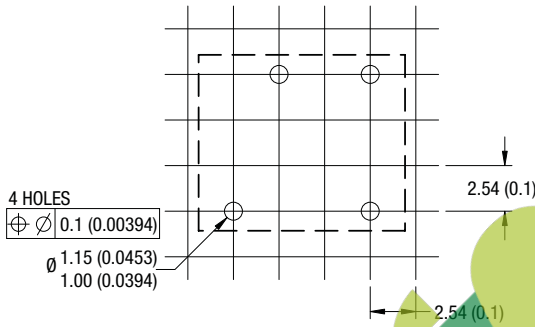

4 Pin SIP Package

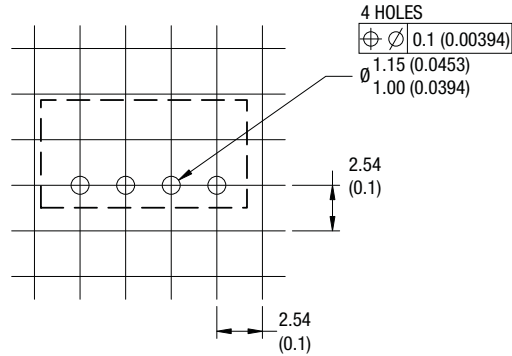

TUBE OUTLINE DIMENSIONS

8 Pin DIP Tube

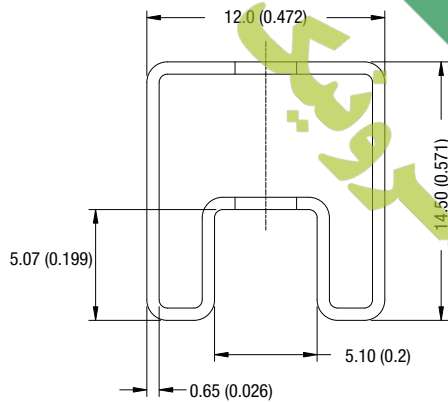

4 Pin SIP Tube

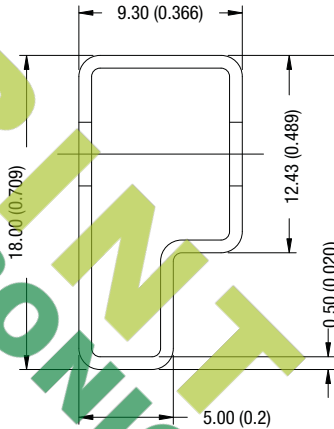

Unless otherwise stated all dimensions in mm (inches) ± 0.5 mm.
 Tube length (8 Pin DIP) : 520mm ± 2 mm (20.47).
 Tube length (4 Pin SIP) : 520mm ± 2 mm (20.47).

Tube Quantity : 35